

# 2N D14 K 40

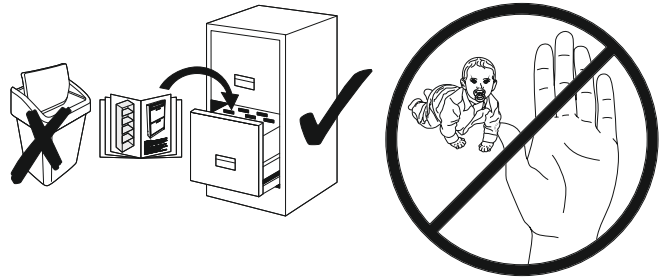

<b>a1</b> 8x35 x...(x24)	<b>c1</b> Euro 4x13 x...(x6)	<b>bc0</b> x...(x3)
<b>bc1</b> x...(x3)	<b>c3</b> Euro 6x13 x...(x8)	<b>d2</b> x...(x8)
<b>e0</b> x...(x12)	<b>e1</b> x...(x12)	<b>f1</b> x...(x12)
<b>i2</b> 4x16 x...(x12)	<b>g1</b> x...(x6)	<b>h1</b> L-368 x...(x1)
<b>k3</b> 4x22 x...(x4)	<b>h2</b> L-220 x...(x1)	<b>m</b> x...(x1)
<b>n1</b> 3x16 x...(x10)	<b>n2</b> 3,5x16 x...(x24)	<b>p01</b> x...(x12)
<b>r4</b> x...(x16)	<b>o1</b> x...(x4)	<b>o2</b> x...(x4)
<b>w16</b> x...(x2)		

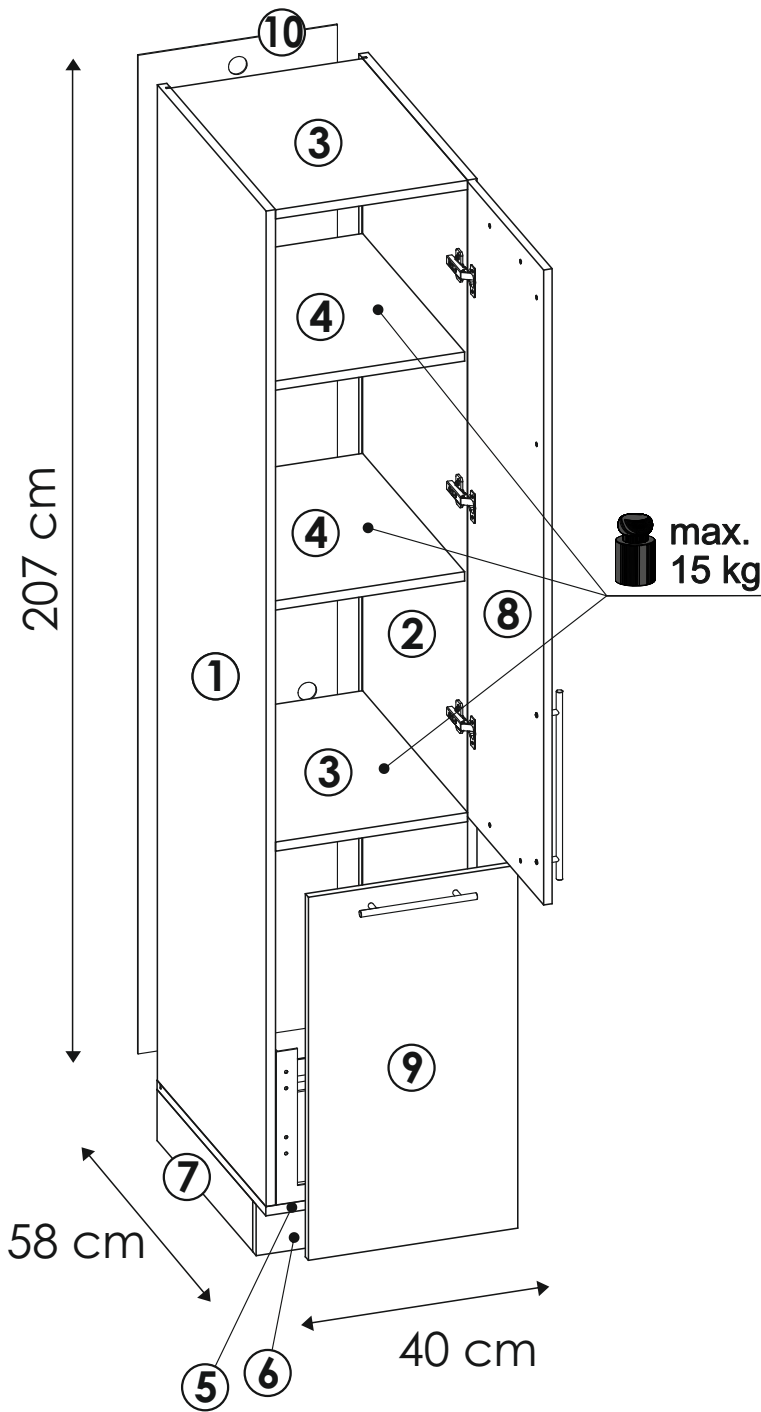
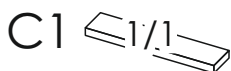

- |       |       |
|-------|-------|
| ① -C1 | ⑥ -C1 |
| ② -C1 | ⑦ -C1 |
| ③ -C1 | ⑧ -C1 |
| ④ -C1 | ⑨ -C1 |
| ⑤ -C1 | ⑩ -C1 |

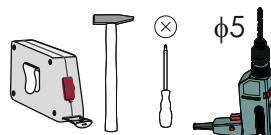
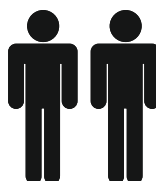

1

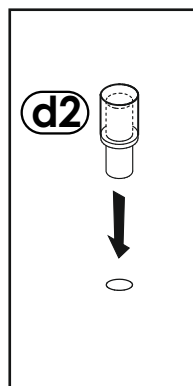
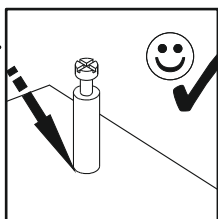
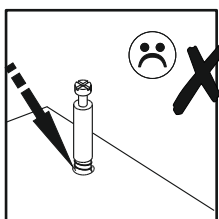
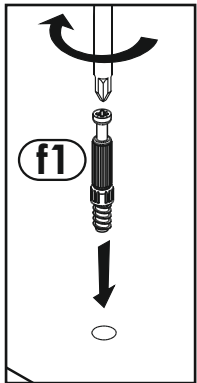
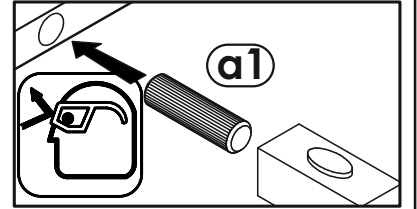
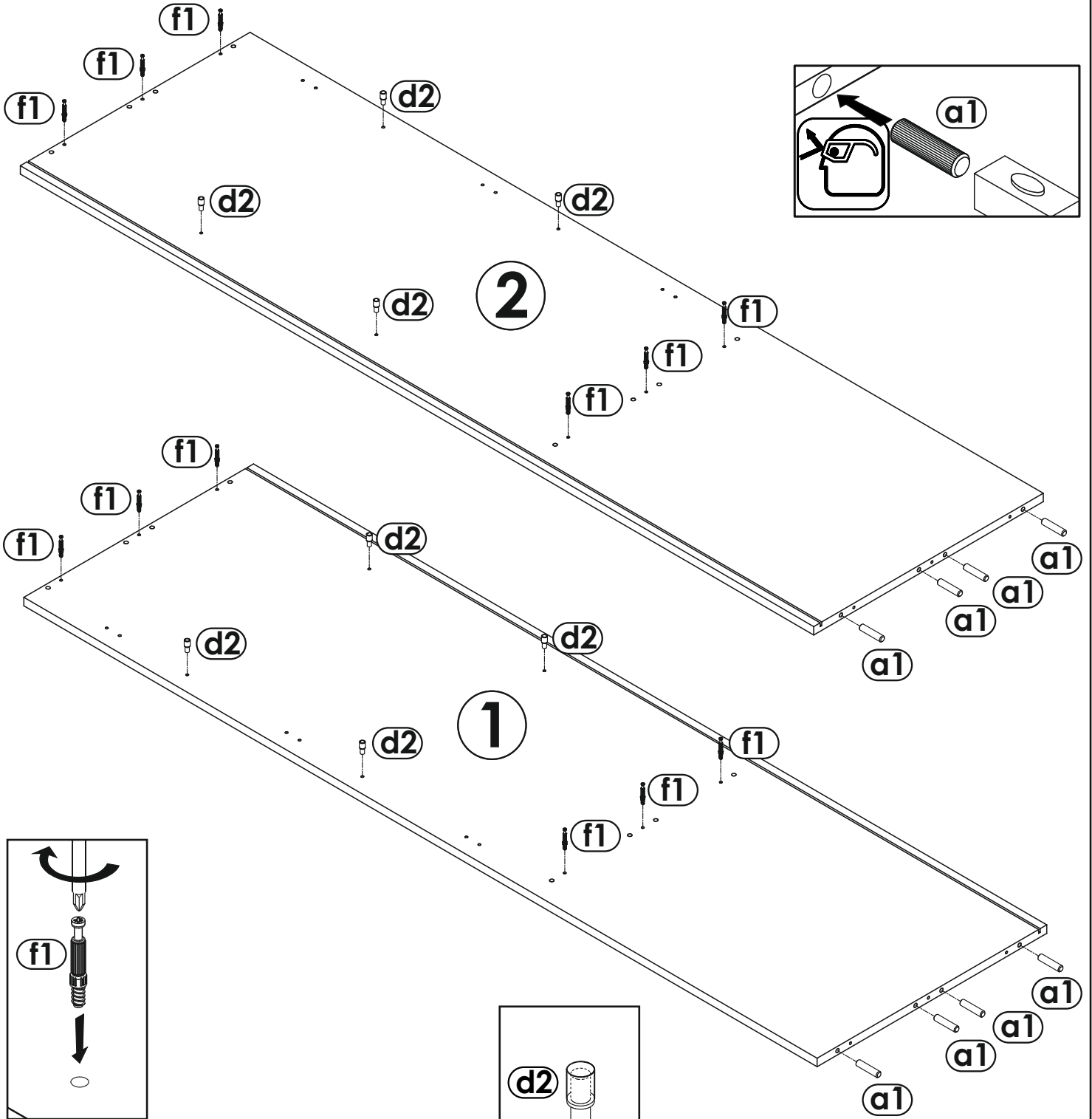
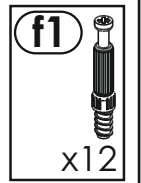
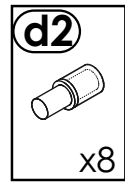
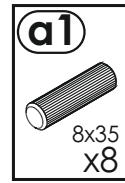
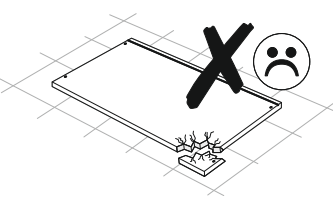
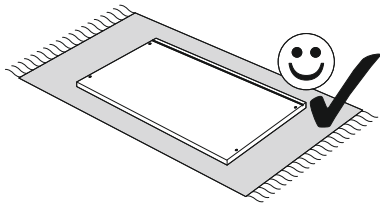

2

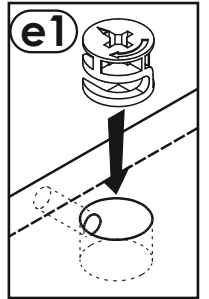
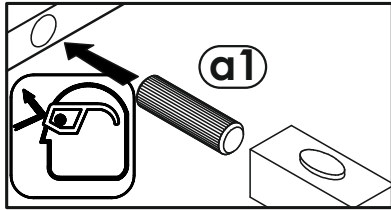
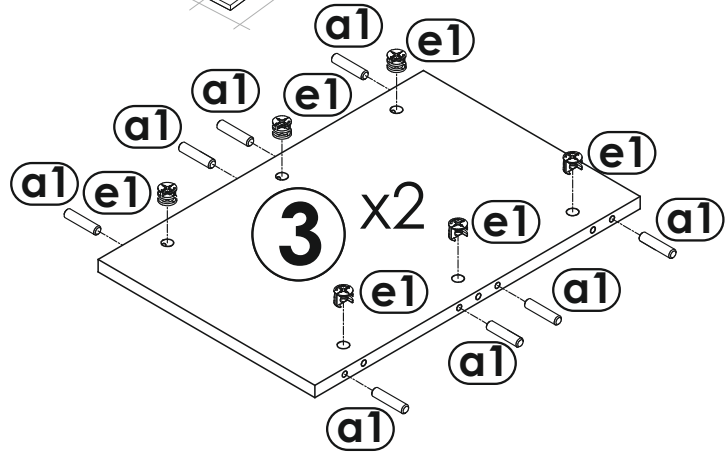
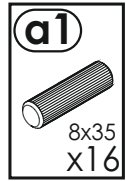
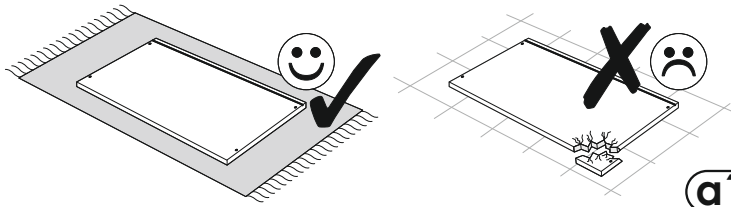

3

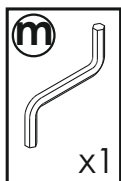
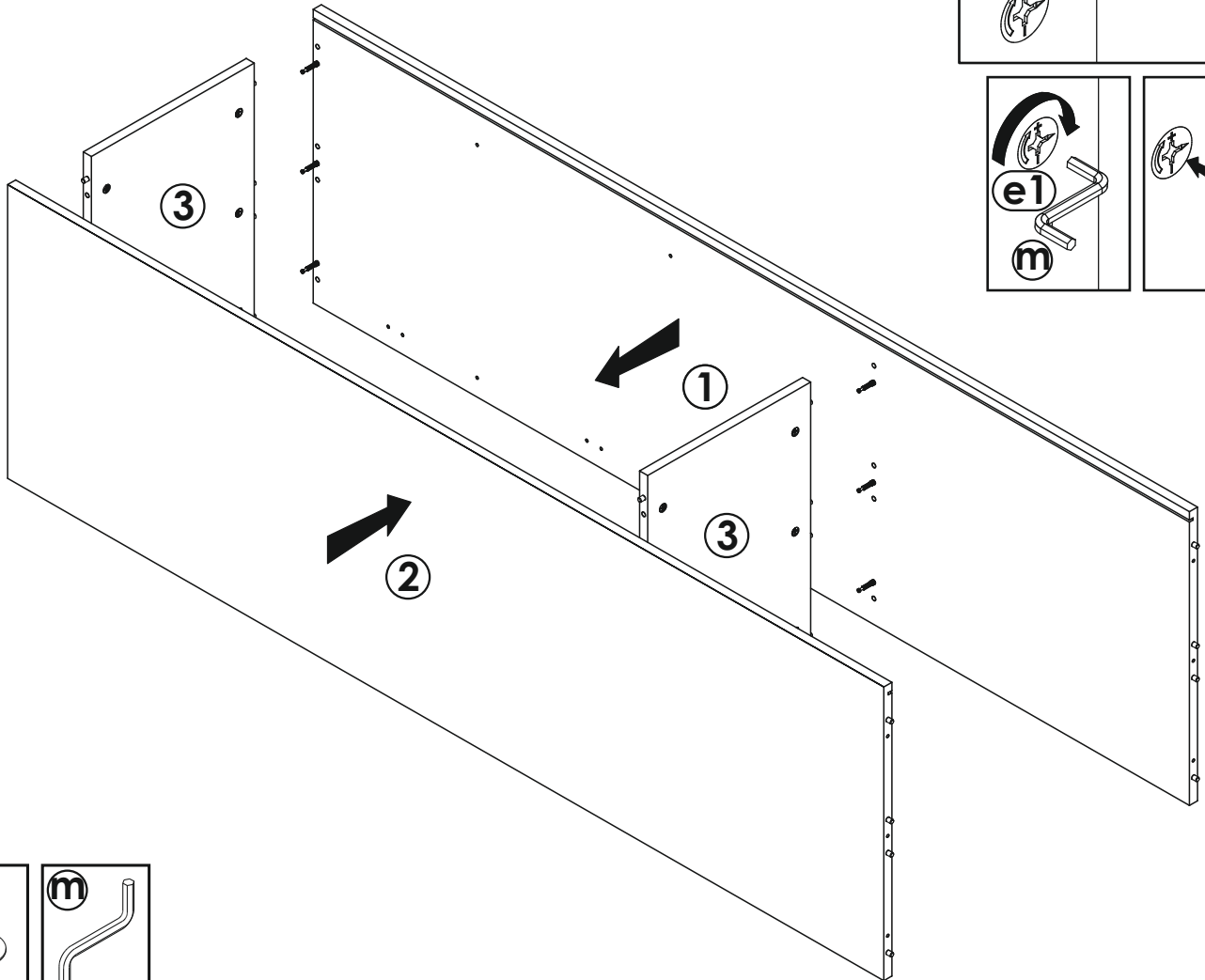
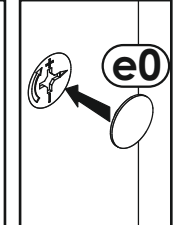
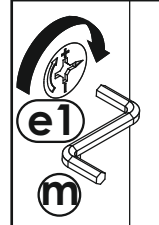
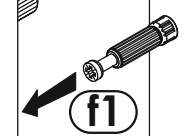
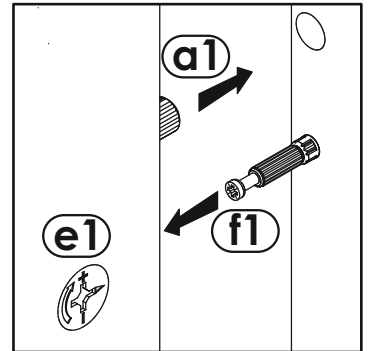
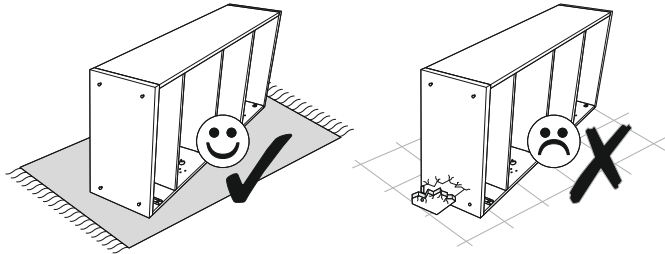

4

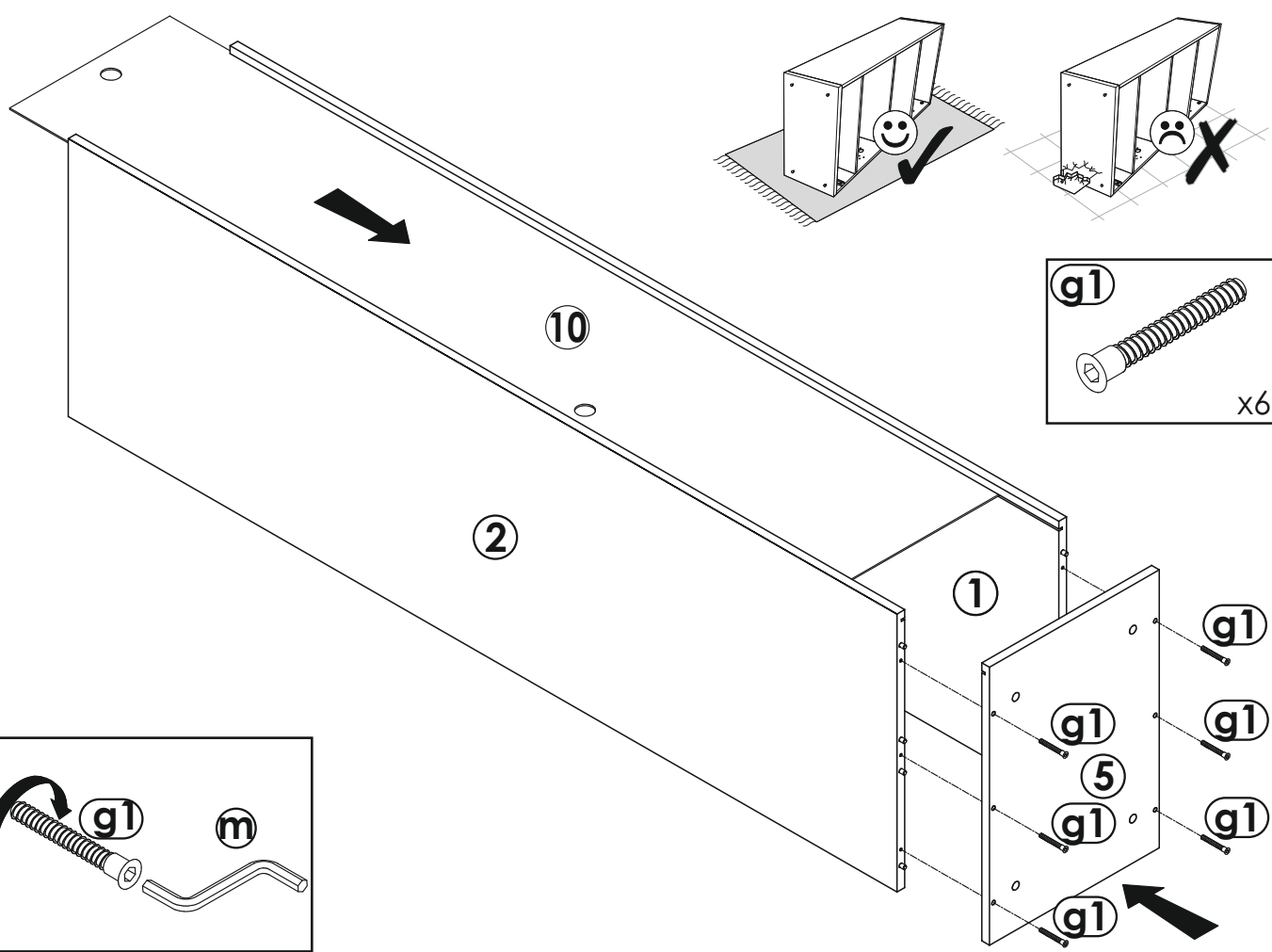

5

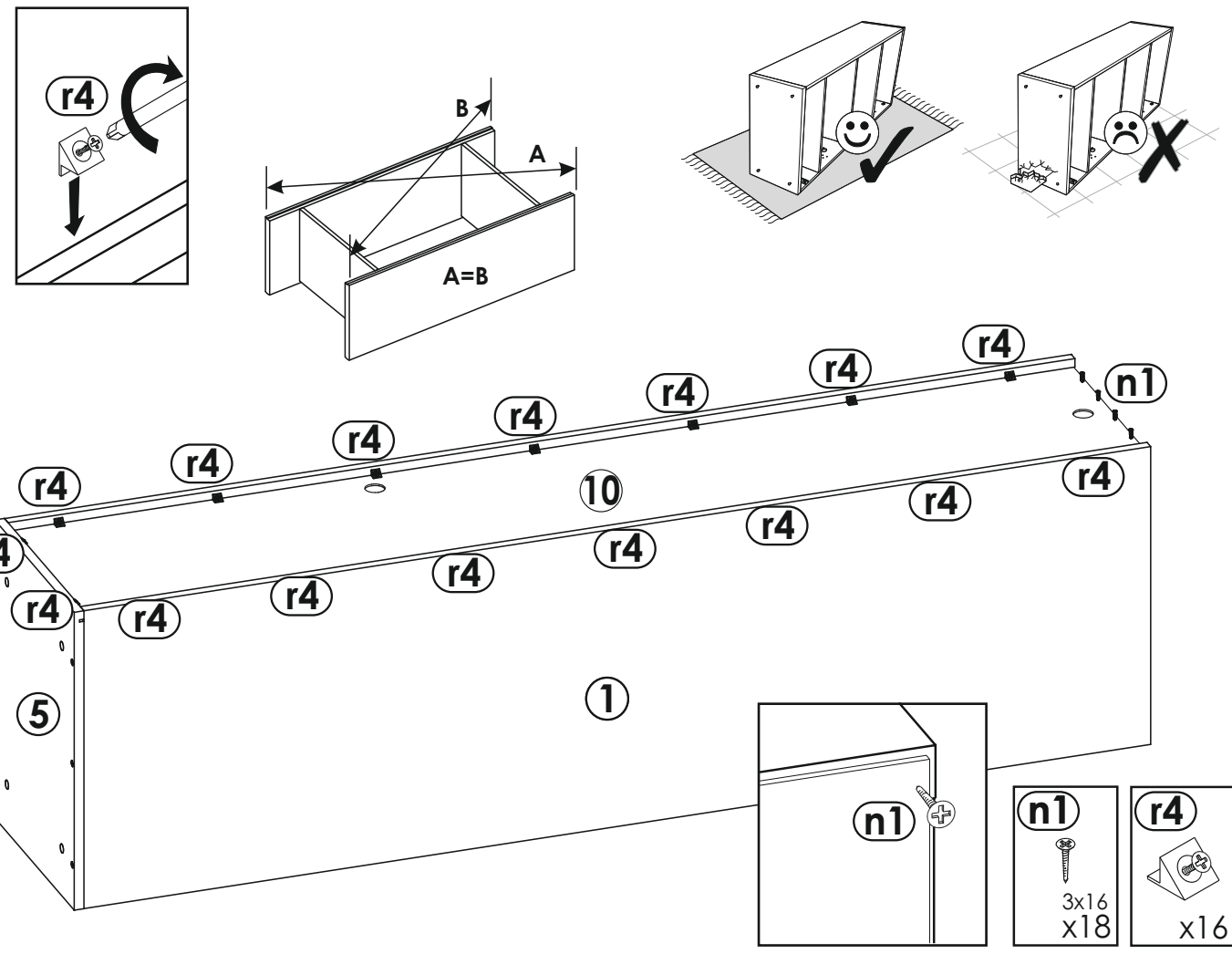



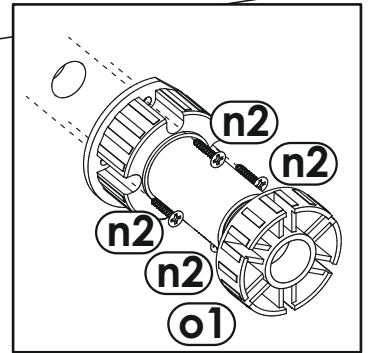
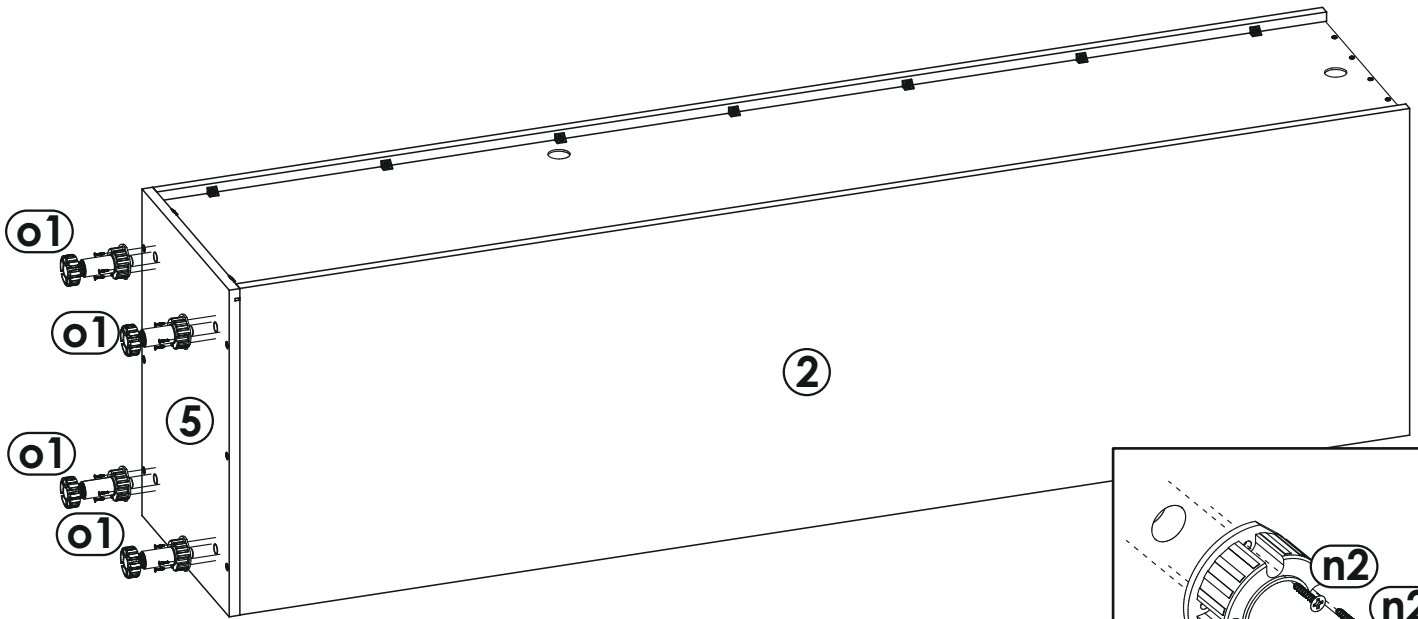
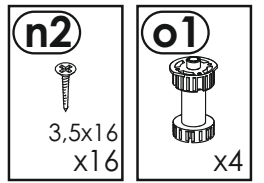
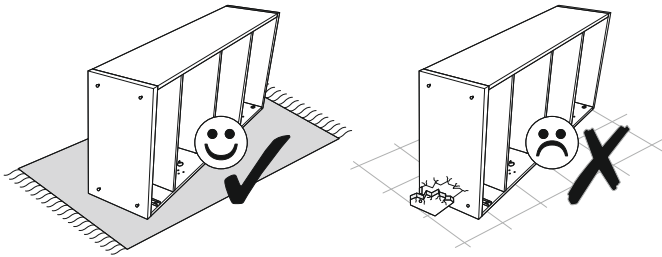

6

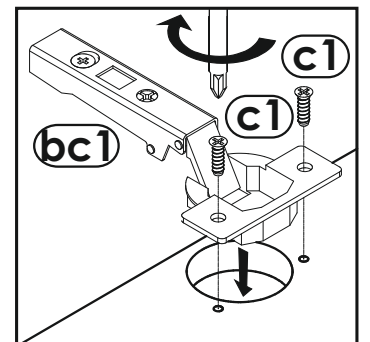
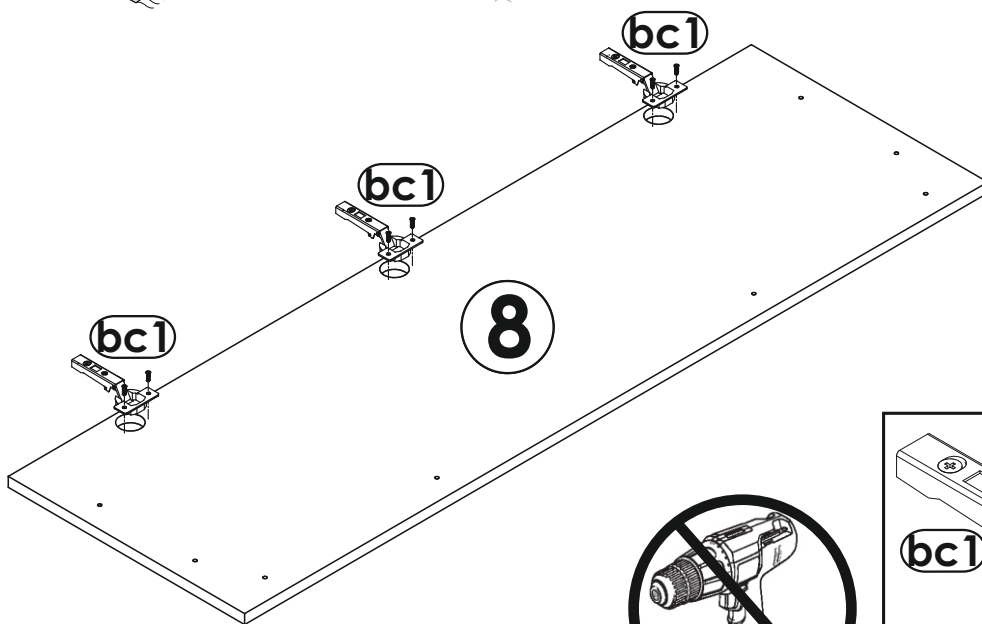
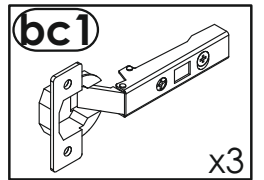
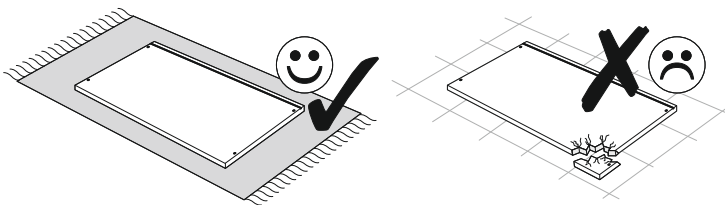

7

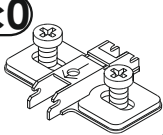

# 8

- bc0**  
  
 x3
- p01**  
  
 x6
- n2**  
  
 3,5x16  
 x8
- o2**  
  
 x4

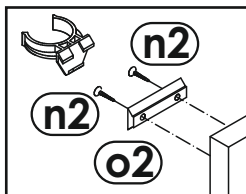
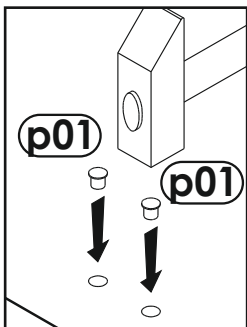
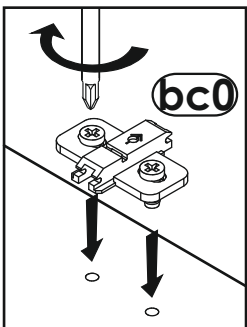
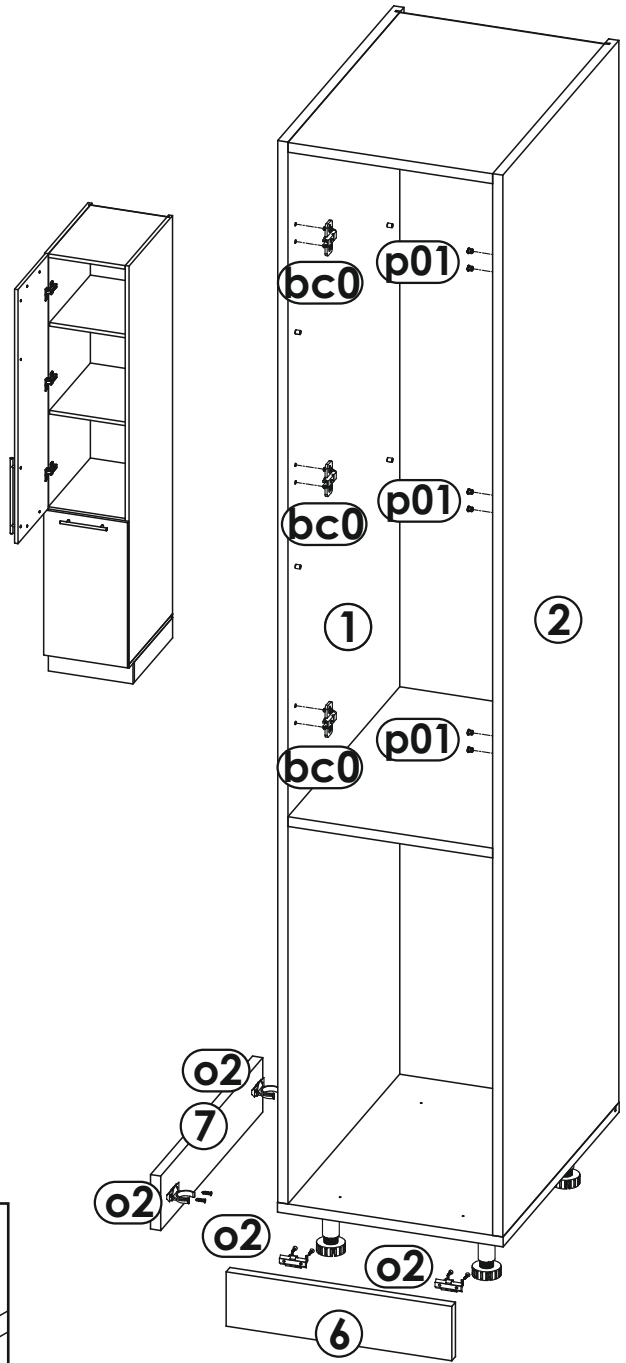
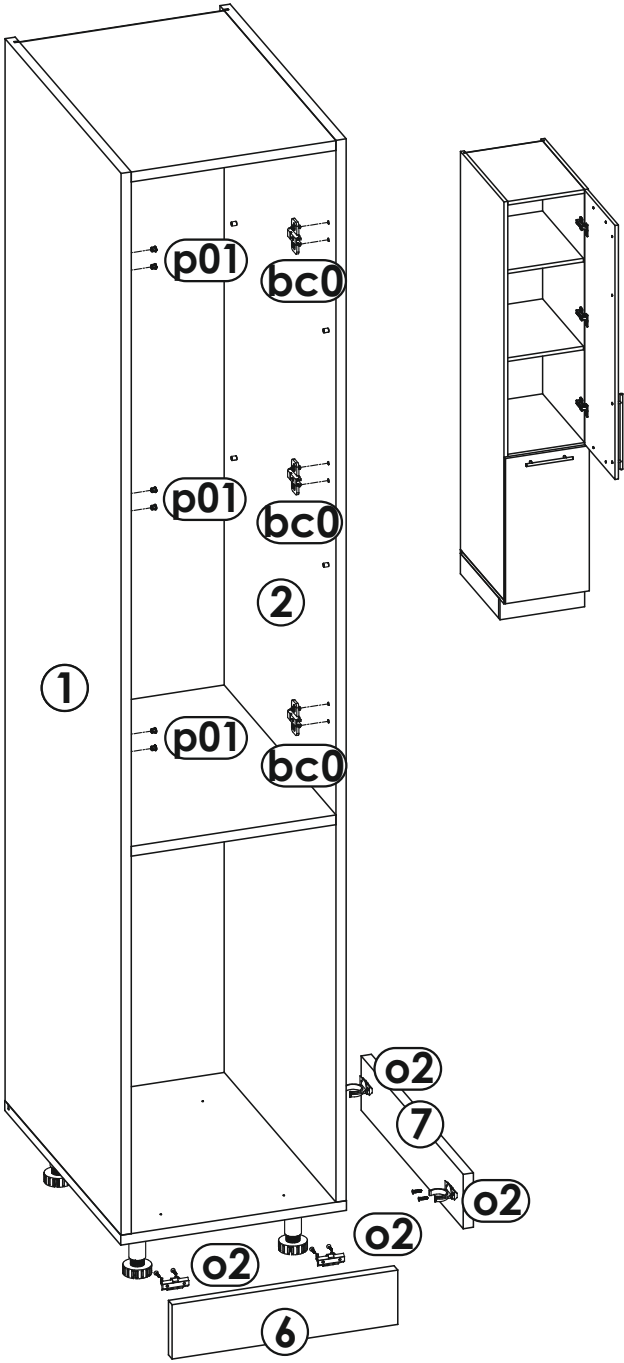
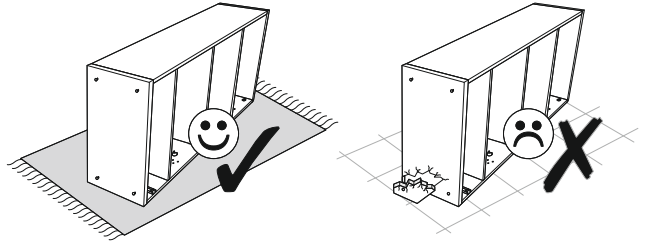

9

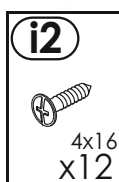
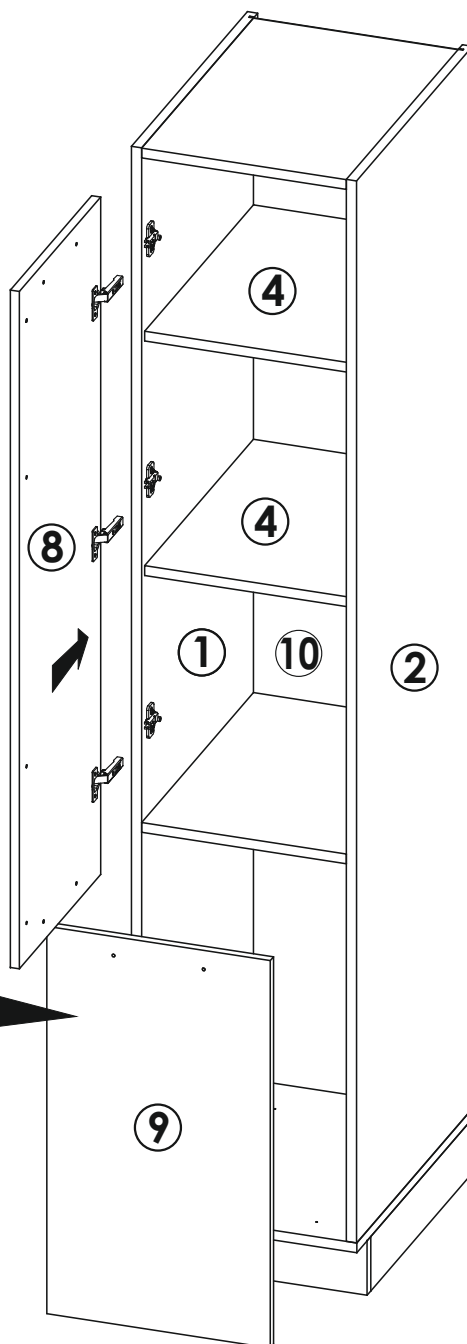
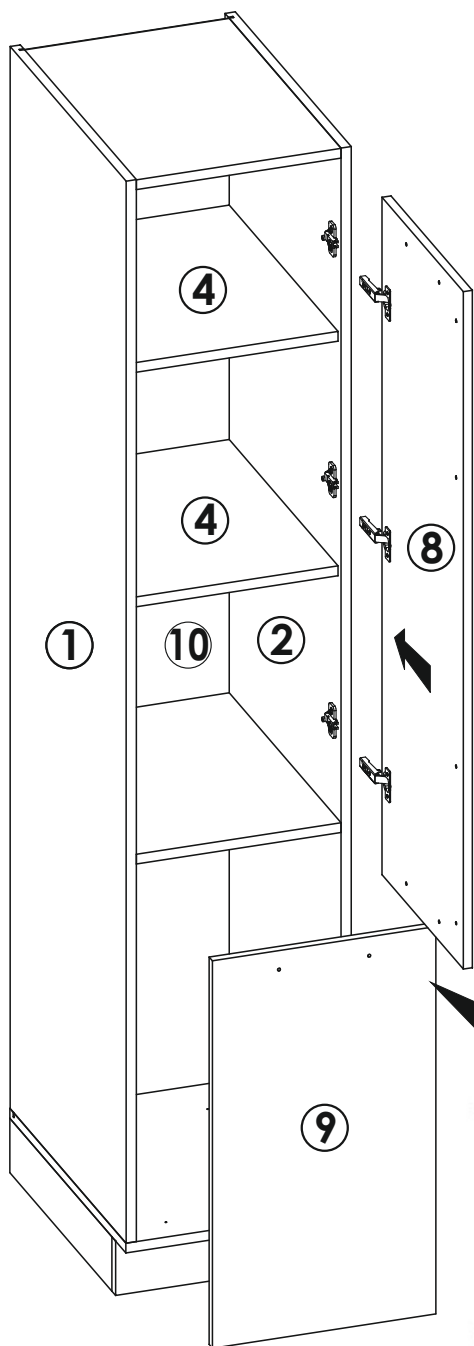
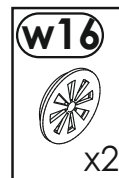
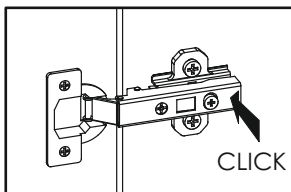
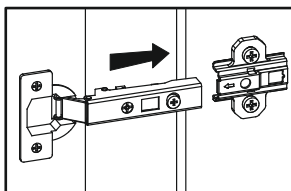
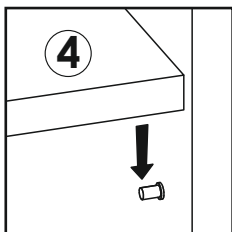
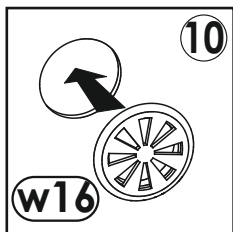

# 10

